

Bible Adventure/Aventura Biblica

This four day program for kids has a bilingual option good for missions and other applications. The following are segments and schedules available for your use. This is a low tech Bible school or kids program so can be used outdoors as needed. The optimal schedule is formatted for a 2.5 hour program with 20 minute rotations. This program can be facilitated by 16-20 people, but including local church members as additional volunteers is beneficial. See the Schedule Guide for example schedule for the first three days and a variation for day four. The variation is done to be able to invite the parents to come for a parent program which is a great opportunity for parents to see their kids shine, to hear the gospel and become familiar with the local church.

Overview:

| | Bible Point | Memory Verse | Bible Passage | Lesson |
|-------|----------------------|--------------|------------------------|--|
| Day 1 | Jesus is our Creator | John 1:1 | Genesis 1:26-27; 3 | Creation and The Fall |
| Day 2 | Jesus is our Hope | Romans 3:23 | Matthew 20:1-16 | Parable of the Workers in Vineyard |
| Day 3 | Jesus is our Savior | Romans 5:8 | Luke 23:32-43 | Crucifixion and The Thief on the Cross |
| Day 4 | Jesus is our Friend | Romans 15:13 | Matthew 28:1-15; 19-20 | Resurrection and New Life |

Leaders needed for the Bible Adventure program include:

Music Leader

Bible Teacher

Puppeteers

Game Leader

Craft Leader

Nourish Leader (snack and memory verse)

Trek Guides (2 for each group; one male and one female are best)

Registration Leader

Music Leader

The music leader will lead songs during worship and closing as well as lead a rotation station with music and motions. They should be gifted in music and may need to play a guitar if there is no access to electricity. Teach a new song each day and match the theme of the day to an appropriate song such as Jesus is my friend with Jesus es Mi Amigo.

Bible Teacher

The Bible teacher will teach the lesson in the opening assembly and the closing review. They should be gifted in teaching and animated in speaking so as to grab the attention of the children. If you choose, you can have the local pastor do the closing review, but provide him with the material and time frame to keep the message consistent.

Puppeteers

When using this curriculum in Spanish speaking countries, selecting native speakers or those who can read Spanish aloud would be the optimal choice for puppeteers. Another option is having one or two people from the mission team manipulate the hand puppets and two Spanish speaking individuals from the local church read the script. If you are able to set it up in time for local church members to practice, you can practice having the puppets “speak” as they read simultaneously. See Skit Guide for performance details. You will also help set up the PVC puppet stage.

Game Leader

This person is responsible for preparing the equipment, setting up the games and instructing the kids. Kids will rotate to you by age group, but when they come to this rotation take note if you need to adapt to smaller sub-groups. This can be helpful to keep bigger kids who may be at the top end of the age range from running over smaller kids. You may also need to adapt for kids who have special needs. Keep this in mind and be prepared to be flexible when giving instructions for play.

Craft Leader

This person is responsible for preparing the crafts, setting up, instructing the kids and helping them as needed. You will also want to remind the trek leaders to participate in helping the kids with their craft as while crafts are fun for most kids, there are those kids who get frustrated easily if they can't figure it out right away. This is a great opportunity to show patience and love to kids who may not get this at home. A good tip is to bring a rope and clothespins to keep the crafts secure until the kids pick them up at the end of each day. It is important to hold the crafts at the craft station as to keep kids focused on each station without the distraction of their craft in hand.

See Crafts rotation guide for daily craft instructions and templates.

Trek Guides

The trek leaders will be assigned a color with coordinating name tags to help keep up with your kids. They will also be responsible for collecting the name tags from the kids to use the next day and the security cards from the parents upon pickup. Due to a small number of leaders typical for a mission trip, trek guides will not only keep time and take your kids from rotation to rotation, but you will be the extra hands for crafts or feet for games, etc.

At the end of each day, the parent or guardian will pick up the child from your group by giving you the security card portion of the registration form. Take the child's name tag lanyard and put the security card in the pouch. The Trek Leader will re-distribute the same card back to the parent or guardian upon drop-off the next day. Doing this simultaneously with giving the child their name tag lanyard will help things go smoothly. If kids are pre-registered, use this to help you prepare some name tags in advance.

Registration Leader

When using this program for a mission trip, it is vital to include a member of the local church to help with registration. Registration cards will be filled out by the parents and will have a section of the card that they will bring back daily to pick up their child. This way if they need a friend or relative to pick up the child, this will be confirmed since the parent has entrusted this person with the pick up card. If the pick up card is lost, the parent will have to show their ID which coincides with the name on the registration form or be verified by the local pastor for security purposes.

Have the local church members help with preparing name tags if kids are pre-registered. This will make the first day of the event go much more smoothly.

Bilingual Registration Form Template with Security Card

| | |
|--|--|
| Child's Name/ Nombre del Niño | Child's Name/ Nombre del Niño |
| Parent or Guardian/ Padre o Guardián | |
| Email/ Correo Electrónico | |
| Phone Number/ Número de Teléfono | |
| Additional Name and Phone/ Nombre Adicional y Contacto Telefónico | |

| | |
|--|--|
| Child's Name/ Nombre del Niño | Child's Name/ Nombre del Niño |
| Parent or Guardian/ Padre o Guardián | |
| Email/ Correo Electrónico | |
| Phone Number/ Número de Teléfono | |
| Additional Name and Phone/ Nombre Adicional y Contacto Telefónico | |

| | |
|--|--|
| Child's Name/ Nombre del Niño | Child's Name/ Nombre del Niño |
| Parent or Guardian/ Padre o Guardián | |
| Email/ Correo Electrónico | |
| Phone Number/ Número de Teléfono | |
| Additional Name and Phone/ Nombre Adicional y Contacto Telefónico | |

Have the parent or guardian fill out the form completely including printing the child's name.

Using an inexpensive hand-held perforating tool, perforate or cut off the security portion of the card and give the security section to the parent. They will return the card daily to the Trek Leader upon pick-up who will then re-distribute to the parent upon drop-off the next day.

Rotation Stations

Worship/Adoración

This is a time to engage the kids with both the curriculum and music. Make a big deal out of the Bible Point of the day and ask the kids to respond whenever they hear the daily Bible Point throughout the day. For example Day 1 “Jesus is our Creator”. Have the kids respond with a word or sound that exudes praise, joy or celebration. For the bilingual portion, I recommend using “¡Arriba, wepa, wepa!” which is just a term of encouragement as you would yell “Go!” for a team you are rooting for and wepa is like “Yay!”. For the english version, I would use a term that coincides with your theme so for example for the camping theme you could use a wolf’s howl such as owooooo or use a contemporary word for amen such as having the kids yell, “No doubt!” Typical opening session will include 1-3 songs, welcome, Bible lesson, puppet skit and prayer before dismissal to rotation stations. Music leaders will also lead a rotation station for music and motions. If you have a large group of kids, it is important to designate one song specifically for each age group to learn well. This way, they will have the opportunity to show the parents what they have learned during the last day closing in which we will invite and include their parents. Music is a great way to teach theology so make sure the songs you are using are both fun and full of content. There will be more instruction on the music portion in the information on the closing segment. If you have a low tech environment, someone who can play the guitar while leading music is optimal.

See Lesson Guide, Music Guide, and Puppet Skits for details.

Games/Juegos

Game time is one of the kids favorite rotations. This is a great time to have kids model sportsmanship and even point out when kids miss the mark as an example of our sin nature. Make sure a large number of kids are engaged in each activity. This is not a time for most kids to sit out while only a few play. The Games Guide will give you 8 activities to choose from. It is always good to have at least 2-3 ready to go each day. If the kids are really enjoying the first one, it is fine to keep playing. The second option is there in case things aren’t going to plan and you need to pivot. You will also want to remind the trek leaders to participate in keeping the kids on track or helping with secondary groups if you need to divide the kids into smaller segments. See Game Guide for game options.

Crafts/Manualidades

Craft time is a great opportunity to use what kids are making to reinforce the lesson. Have kids tell you how their craft can help them remember the Bible adventure for the day. Don't forget to encourage them to yell out when they hear the daily Bible Point.

Day 1 Jesus is our Creator: Snake Craft

Day 2 Jesus is our Hope: Missing the Mark Target Craft

Day 3 Jesus is our Savior: Cross Craft

Day 4 Jesus is our Friend: Gospel Friendship Bracelets

See Craft Guide for detailed instructions and templates.

Nourish/Nutrir (Snack & Memory Verse) Leader

This person is responsible for distributing the snacks, leading the memory verse, and organizing, dispensing and collecting the daily puzzles. This rotation is to nourish the body and soul with both snacks and a time for the kids to hide God's word in their hearts. You can use motions with the words to teach the verse of the day while they eat and then let the kids remember what they learned by assembling puzzles to complete the verse. Put the kids in groups of 2-4 depending on the number of puzzles you have available. Add an element of fun by having the first team and then each team stand and say the verse as they complete their puzzle.

Preparing the Puzzles

You will need blank puzzles with 12 pieces. In planning for a program of 100 kids, I would recommend 36 puzzles to use over the four day program. Using colored sharpies, put no more than 1-2 words on each piece. Don't forget to have a piece that has the reference. Mark on the back of each puzzle piece the day for use and the number of the puzzle. For example the first puzzle for day 1 will have 1-1 on each of the 12 pieces, the second puzzle will have 1-2 on each piece. Continue marking 9 puzzles for day 1. The puzzle for days will have 2-1 on each piece of the first puzzle, 2-2 on the second and so on through the 9 puzzles for that day. If your event has pre-school age children, use motions to teach the verse, colors to point out the words and group the kids so that each group has one adult to help with the puzzle.

Tip: Keep your hand lifted off the puzzle surface when writing on the puzzles so that you don't smear the ink. Use sharpies in multiple colors to help pre-readers identify words.



Día 1

Punto Bíblico: Jesús es nuestro Creador

Versículo de Memoria:

Juan 1:1 En el principio ya existía el Verbo, y el Verbo estaba con Dios, y el Verbo era Dios.

Día 2

Punto Bíblico: Jesús es nuestra Esperanza

Versículo de Memoria:

Romanos 3:23 Pues todos han pecado y están privados de la gloria de Dios.

Día 3

Punto Bíblico: Jesús es nuestro Salvador

Versículo de Memoria:

Romanos 5:8 Pero Dios demuestra su amor por nosotros en esto: en que cuando todavía éramos pecadores, Cristo murió por nosotros.

Día 4

Punto Bíblico: Jesús es nuestro Amigo

Versículo de Memoria:

Juan 15:13 Nadie tiene amor más grande que el dar la vida por sus amigos.

Closing: Message & Music/Mensaje y Música

This is the time to reinforce what the kids have learned for the day and leave them with some final thoughts. Soliciting the local pastor to give the closing message will be beneficial in promoting the local church.

Here is an example schedule for the closing time service:

Worship Songs (6 min)

Message from the Local Pastor (10 min)

Prayer (1 min)

Worship Song (3 min)

Parent Program

Parent program will include welcome by the program director, Missions leader or pastor. Parent's will be given an earlier time to return for the last day. The Parent Program will include 3 songs by the entire group or one song by each age group if you have a large number of children as well as a gospel presentation by the local pastor. This is a great time for parents to see their kids shine with the light of Jesus.

* Find out how much time the pastor wants for his gospel presentation. If time allows, you can do two songs per group or an additional song can be performed by a larger group of children such as the two oldest groups. This is often helpful if there is one song that all the kids love. Or the pastor may want an encore of the Bridge of Life skit as an introduction to his gospel message.

Bible Adventure Schedules

Monday: Prep Day

Tuesday - Thursday: Open at 9am for Welcome & Registration, 30 Minute Worship with Music & Lesson, 20 Minute Rotations, 30 Minute Closing

| Mon-Thurs | Blue Crew (Littles) | Red Crew (Middles) | Green Crew(Bigs) |
|-------------|--|---------------------|---------------------|
| 9:00-9:15 | Welcome & Registration/Bienvenido y Registro | | |
| 9:30-10:00 | Worship/Adoración | | |
| 10:00-10:20 | Nourish/Nutrir | Music/Musica | Crafts/Manualidades |
| 10:20-10:40 | Music/Musica | Crafts/Manualidades | Games/Juegos |
| 10:40-11:00 | Crafts/Manualidades | Games/Juegos | Nourish/Nutrir |
| 11:00-11:30 | Games/Juegos | Nourish/Nutrir | Music/Musica |
| 11:30-12:00 | Message & Music/Mensaje y Música | | |

Friday: Same schedule, but parents are invited to return early for a parent program.

| Friday | Blue Crew (Littles) | Red Crew (Middles) | Green Crew(Bigs) |
|-------------|--|---------------------|---------------------|
| 9:00-9:15 | Welcome & Registration/Bienvenido y Registro | | |
| 9:30-10:00 | Worship/Adoración | | |
| 10:00-10:20 | Nourish/Nutrir | Music/Musica | Crafts/Manualidades |
| 10:20-10:40 | Music/Musica | Crafts/Manualidades | Games/Juegos |
| 10:40-11:00 | Crafts/Manualidades | Games/Juegos | Nourish/Nutrir |
| 11:00-11:30 | Games/Juegos | Nourish/Nutrir | Music/Musica |
| 11:30-12:00 | Parent Program | | |

Bible Adventure Lessons

Day 1

Bible Point: Jesus is our Creator

Bible Verse: John 1:1

In the beginning was the Word, and the Word was with God, and the Word was God.

Scripture Passage: Genesis 1:26-27; Genesis 3

Lesson Title: “Where are you from?”

Can anyone guess where I am from? Where are you from? Whenever someone asks you that, most of us think about where we were born or where we have lived most of our lives; but I want to go all the way back to the very beginning. Where do you think that was?

This week we are going to have a great adventure! We are going to walk through the Bible to some places that Jesus walked starting all the way to when the world was created. If I say, “In the beginning...?” What do you think of next?

It is true that in the beginning God created the heavens and the earth. Today’s adventure begins in the Garden of Eden. The garden was the perfect place that God created for Adam and Eve to live. They had it so good! The temperature was always perfect, the animals didn’t fight each other and best of all they got to walk with and talk to God face to face.

Did you also know that Jesus was there in the beginning? The Bible tells us that Jesus was with God in the beginning and that without Him nothing was made that has been made. That includes me and you!

How many of you like searching for clues? Do you like to hunt for treasure? I love finding all these clues in the Bible that make it such a great adventure.

Before I read Genesis 1: 26-27 and I want you to see if you can find the BIG clue that Jesus was there in the beginning.

Then God said, “Let us make mankind in our image, in our likeness, so that they may rule over the fish in the sea and the birds in the sky, over the livestock and all the wild animals, and over all the creatures that move along the ground.”

So God created mankind in his own image,
in the image of God he created them;
male and female he created them.

Did you find the clue? That's right God said "let us make mankind in our likeness"

Who did the verse mean by "us"? Yes! Jesus is our creator.

How many of you have heard the story of Adam and Eve? Did you know that is not just a story, it is HIS - story. The entire Bible points us to the story of Jesus so listen carefully to what happened in the garden.

God told Adam and Eve they could eat from any tree in the Garden except the tree of knowledge of good and evil or they would surely die. But Satan, in the form of a snake tempted Eve, making her doubt God. "You won't die", the snake said. "You will be like God instead!" So Eve ate of the fruit and gave it to Adam who disobeyed God and also ate the fruit. From that moment on, sin entered into what was a perfectly created world. Adam and Eve who were created to live forever, now would die. Not only would they die physically, but their friendship with God was broken. Their relationship with God died that very day. God banned them from the Garden and told them and also the snake what the punishment for their sin would be.

God also told Adam and Eve that one day, the snake Satan would be crushed. We will learn more about this in adventures through the Bible this week.

Day 2

Bible Point: Jesus is our Hope

Bible Verse: Romans 3:23

For all have sinned and fall short of the glory of God.

Scripture Passage: Matthew 20:1-16

Lesson Title: "That's Not Fair!"

How many of you do chores around the house? Do you get an allowance for doing the chores? Do you do the chores for the money? Raise your hand if you do chores because you think your parents will be happy with you if you do them!

Let's say there is a special job your family needs help with - like cleaning up the yard. What if they told you that if you cleaned up the yard, you would get \$20? Let's say you worked on the yard all day, but your brother had a soccer game that morning so he didn't help you until after lunch. Then at the end of the day, your parents gave you both \$20. What would you say? "Thank you??" or "That's not fair!!"

When we say something is not fair, it is because we think we deserve something else.

In today's Bible adventure Jesus tells a story about some workers who think they deserve more than the others. There is a twist to this story from Matthew 20:1-16 that you might not see coming so listen closely for clues!

There was a landowner who needed workers for a day's labor to work in his grapevines. What do you think he might have needed them to do? Pick grapes?

The landowner went out first thing in the morning, found some workers and agreed to pay them a fair day's wage and hired them. Later that morning, he went back to where he hired the first workers and saw more workers standing around so he hired them as well. He did the same thing at noon and twice more he went back again. When he saw more workers there, he asked them why they had been standing here all day long doing nothing and they said because no one hired us. So he hired them too!

When the day was over he told his foreman to call them over to get paid starting with the ones he hired last. Just as an example, let's say a day's wage was about \$100 in today's money. The group that was hired last, got \$100 each, the next group got \$100 each, the next group got \$100 each, and the next. When it came to the last group, they were excited and expecting to

get more! When the landowner paid them the same fair day's wage that they agreed on when he hired them, they complained. Any guesses what they might have said? "That's not fair!" comes to mind.

You might think the worker who worked all day deserved more than the others, but didn't he get the pay he was promised? The truth is that it was perfectly fair because it is not up to them if the landlord wanted to be generous with the other workers.

Our sinful nature makes us think we deserve more than the other person, **but trust me we don't want to get what we deserve!**

Yesterday, we learned that all of us have sinned and fall short of the glory of God. Do you know that we earn wages for our sins? A wage, like in the story of the workers, is payment. Romans 6:23 says that the wages of sin is death.

When God told Adam and Eve not to eat of the tree of knowledge of good and evil, he told them if they did they would die. That snake Satan lied to Eve and told her she would not die! From the moment that they disobeyed God, Adam and Eve would no longer live forever in friendship with God in the garden, but were sent out, their relationship with God was dead and broken and one day their bodies would also die. The wage they earned for their actions and what we earn for our sin today, is death. *If we get what we deserve, we will be eternally separated from God.*

But there is good news! The rest of Romans 6:23 says, "For the wages of sin is death, but the gift of God is eternal life in Jesus Christ our Lord."

Jesus is our Hope to live forever with Him!

Day 3

Bible Point: Jesus is our Savior

Bible Verse: Romans 5:8

But God demonstrates his own love for us in this, While we were still sinners Christ died for us.

Scripture Passage: Luke 23:32-43

Lesson Title: The Adventure Continues

Are you excited to continue the adventure today? So far, we learned that Jesus is our creator and that Jesus is our hope. Today, we are going to trek through the Bible to find out that Jesus is our Savior.

Who remembers what sin is? Let me give you a hint. Anything we... (point to your mouth, then your hands, then your head.) That's right anything we say, do or think that doesn't please God. Think about what sins you have in your life right now. Have you lied to someone? Did you take something that doesn't belong to you? Maybe you had ugly thoughts about someone?

The Bible tells us in Romans 3:23 that all have sinned and fall short of God's perfection. All. So raise your hand if you are a sinner? I am going to raise both hands because like all of you, I have many sins. And remember what does God say we earn because of our sin? Romans 6:23 says the wages of sin is _____?

Wages or what we earn because of sin is death, an eternal separation from God who is perfect and holy which is why our sin separates us from Him. He is perfect and we are not.

Today's Bible adventure about a thief! The story about when Jesus died on the cross comes from Luke 23:32-43.

When Jesus was crucified by the Roman soldiers, two other men were also led out with him to be executed. They led Jesus and the two criminals out to a place called the Skull and they crucified him there, along with the two men—one on his right, the other on his left.

This was the most important date in history! Jesus who never did anything wrong ever allowed himself to be punished, beaten and hung on a cross. Even during his torture He said, "Father, forgive them, for they do not know what they are doing. People stood watching, and made fun of Jesus saying things like "He saved others; let him save himself if he is God; If you are the king of the Jews, save yourself."

One of the criminals who hung there hurled insults at Jesus: "Aren't you the Messiah? Save yourself and us!" But the other thief scolded him saying, "Don't you fear God? We are getting what we deserve, but this man has done nothing wrong."

Then he said to Jesus, "Remember me when you come into your kingdom." Jesus answered him, "Truly I tell you, today you will be with me in paradise."

What did the thief get in the end? Eternal life in Heaven with Jesus!

On the day that Jesus was nailed to a cross and left to die, he had this conversation with two criminals. Unlike Jesus, these criminals deserved to die for their crimes. But one was saved.

The body of the man who asked Jesus to remember him, died that day, but he would not spend eternity in torment and separated from God. He would be given a new body and spend eternity in Paradise with Jesus.

This thief was about to die. He didn't have time to get down from his cross and repay the money he stole or anything else. Salvation is a free gift. All that man did was believe. Believe that Jesus is God's son. Believe that Jesus could save him.

Because we are sinful humans, we try to figure out other ways to please God. We say things like, "God won't judge me if I am a good person and give to the poor or do other good things". But we read the truth directly from God's word in Ephesians where it says that salvation is the gift of God so that no one can boast, which is another word for brag.

I am so glad, I don't earn my salvation because I would for sure mess it up. Jesus is all we need. Jesus is our Savior!

Day 4

Bible Point: Jesus is our Friend

Bible Verse: John 15:13

Greater love has no one than this: to lay down one's life for one's friends.

Scripture Passage: Matthew 28:1-15; 19-20

Lesson Title: Only the Beginning

Yesterday, we left off when Jesus was crucified alongside the thieves, but there was a hint of things to come...

Do you remember from our adventures earlier this week when we learned that Jesus is God?

In today's Bible adventure from Matthew 28: 1-15, He is going to prove it! Listen for the big clue that tells us that Jesus is not just a man.

On the third day after Jesus' death on the cross and his body was placed in a tomb which is like a cave closed with a huge stone, two women went to his tomb. God caused a violent earthquake and an angel came down from heaven and rolled away the stone that closed the tomb. The men guarding the tomb shook in their boots they were so scared, but the angel spoke to the women saying, "Do not be afraid, for I know that you are looking for Jesus, who was crucified. He is not here; he has risen, just as he said."

What was the big clue that Jesus wasn't just a man? Jesus wasn't in the tomb! He had risen from the grave just as He told His disciples that He would!

After being crucified and put in a burial tomb, on the third day, God raised Jesus from the dead. Do you know what that means? Jesus proved He is the Son of God!

Remember that snake, Satan? When Jesus died, Satan probably thought "I won!" But Jesus won the victory over death and over Satan! Jesus is our living Savior!

After Jesus' resurrection, He showed Himself to his disciples and over 500 others. God is so good to give these eye-witness testimonies of His resurrection in the Bible. He loves us so much, he showed us what that means for us in 1 Corinthians 6:14 "By his power God raised the Lord from the dead, and he will raise us also." When we trust in Jesus, He gives us eternal life with him!

We are going to look for one last clue on our adventure. Look for the clue that tells us where we go and what we do next.

Read Matthew 28:19-20

19 Therefore go and make disciples of all nations, baptizing them in the name of the Father and of the Son and of the Holy Spirit, 20 and teaching them to obey everything I have commanded you. And surely I am with you always, to the very end of the age.”

What was the clue to what we should do next? Go and make disciples. That very verse is why your leaders are here today. We want you to know that Jesus is your creator. Jesus is your hope. Jesus is your Savior. And Jesus is your friend. The verse in Matthew that we just read says that He is always with us on our journey!

Pray and talk to Jesus. Read God’s word and He will speak to you. He will never leave you because Jesus loves you and Jesus is your friend.

Crafts/Manualidades

Overview:

Day 1 Jesus is our Creator: Snake Craft

Day 2 Jesus is our Hope: Missing the Mark Target Craft

Day 3 Jesus is our Savior: Cross Craft

Day 4 Jesus is our Friend: Gospel Friendship Bracelets

Day 1: Sneaky Snake Craft

Supplies: Glue dots, green or orange cardstock for snake, red cardstock for snake tongue, scissors (pre-cut items for children in the youngest group), one pair of googly eyes or reptile eyes in 10 -12mm size for each child. You will also need one sheet of paper chains, one snake tail, one snake head, one tongue and two googly or reptile eyes for each child. For humid climates, bring staplers and extra staples to use if glue dots don't hold well.

Pre-cut snake tongue. Pre-cut all items for the youngest group. Feel free to allow older kids to cut out the paper chain, snake head and tail. Instruct kids to create the paper chain first gluing or stapling only the ends when creating their chain. Once the chain is finished, have them wrap the head cutout around the first link and glue only from the nose to the eyes. Then have the kids wrap the tail around the last link and glue or staple it similarly. Once the snake is done, distribute the eyes and tongue for the final touch for their snake.

While they are crafting, ask them questions about the day's lesson in Genesis. The snake's tail has some clues about what they learned that day.



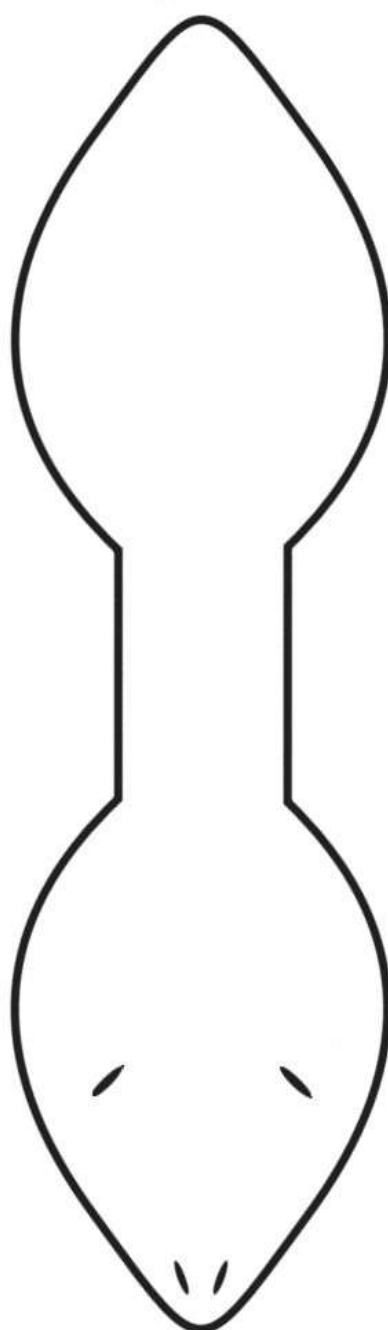
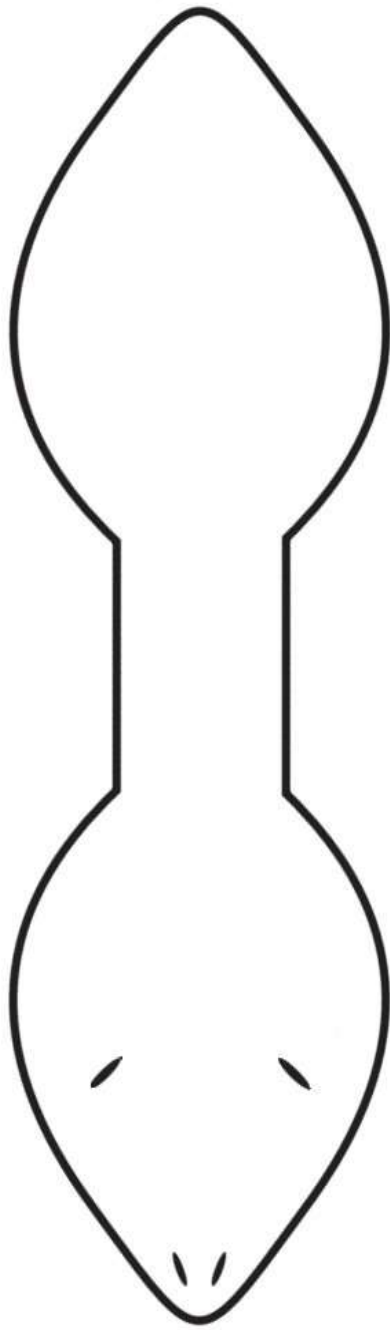

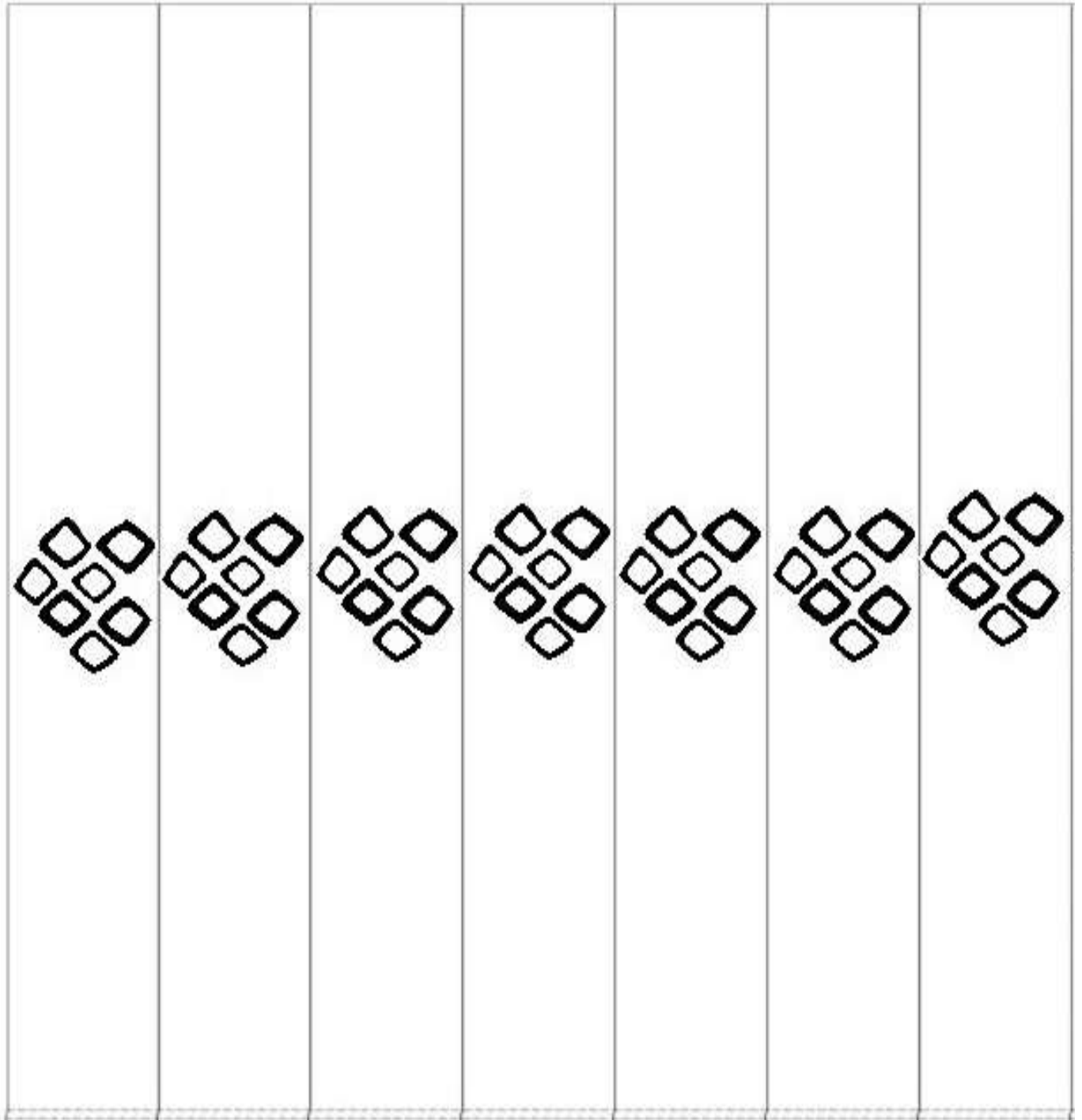

Adán culpó
a Eva,
Eva culpó
a la serpiente.
La relación
del hombre
se rompió,
pero Dios
abrió un camino.
La serpiente ya
no caminó.
El pecado
ingresó.

Adán culpó
a Eva,
Eva culpó
a la serpiente.
La relación
del hombre
se rompió,
pero Dios
abrió un camino.
La serpiente ya
no caminó.
El pecado
ingresó.

Adán culpó
a Eva,
Eva culpó
a la serpiente.
La relación
del hombre
se rompió,
pero Dios
abrió un camino.
La serpiente ya
no caminó.
El pecado
ingresó.

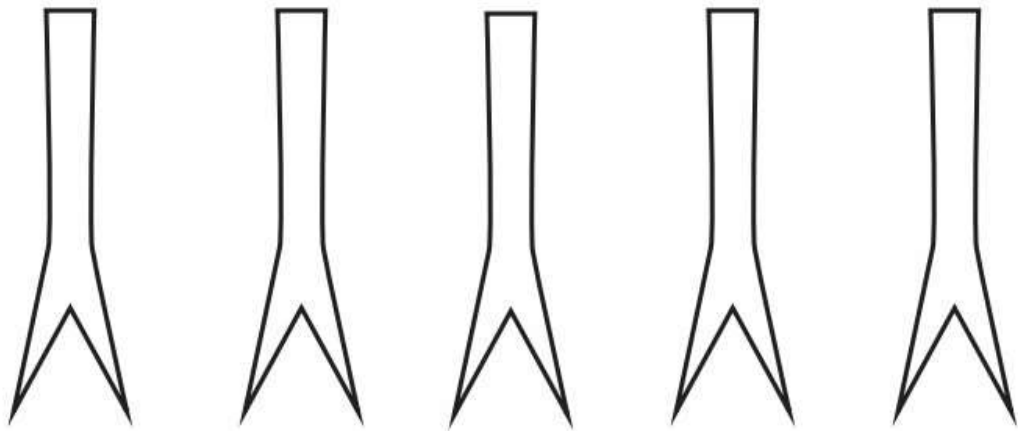
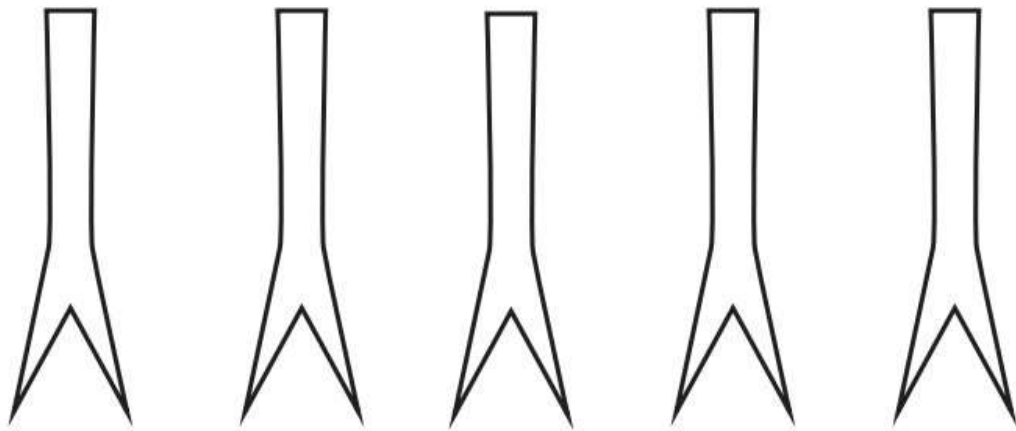
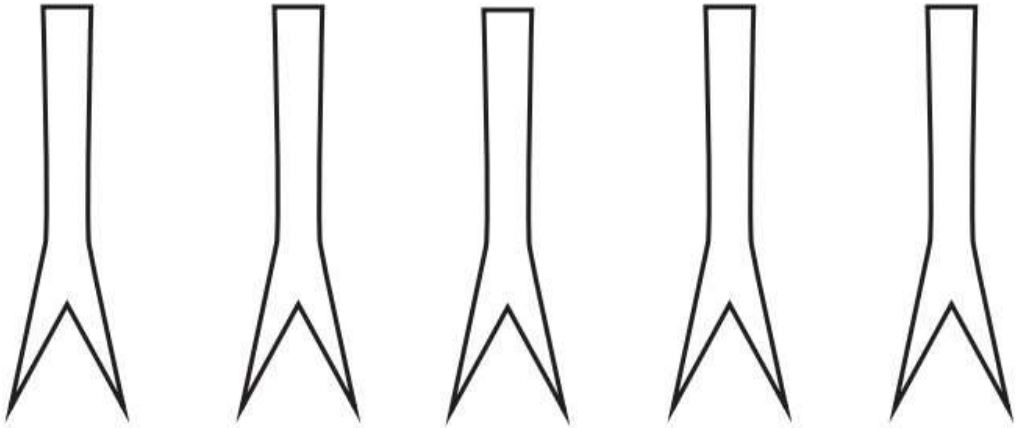

Day 2: Missing the Mark Target Craft

Supplies: Glue Sticks, pre-cut target circles, 9 popsicle sticks per child

Use cardstock in bright colors for the target, making sure the center bullseye circle is printed on red cardstock.

Distribute the memory verse page printed on cardstock and circles and instruct the kids to assemble the target first. Have kids layer the circles so that the largest is at the back and the smallest bullseye circle is on top. Help with gluing as needed so that the bullseye is in the center of the target. Glue the target on the verse page so it acts as base for the target. Assist with gluing as needed.

Once the target is assembled, distribute the 8 popsicle sticks, three rubber bands and a plastic spoon to each child. It is important not to distribute rubber bands at first to avoid them being used for mischief.

To make the catapult, stack 7 popsicle sticks directly on top of each other.

Wrap one end of the stack tightly with a rubber band.

Place the last (eighth) popsicle stick between the first and second popsicle sticks, sliding it to the middle.

Wrap the other end of the stack tightly with the second rubber band.

Make sure your stack has the eighth stick towards the bottom.

Take a spoon and line it up with the eighth stick over the top of the stack so that there are six popsicle sticks between them.

Wrap the last rubber band around the bottom of the spoon and the eighth stick.

Wad up paper balls to use as projectiles.

Try this out with your target and see how often you miss the mark.



Templates for the target craft should be copied on multiple colors of cardstock (except red) to allow for a variety of rings in the target. Please note that there are 15 bullseye circles on that template so not as many copies are needed. Copy the bullseye template on red cardstock.

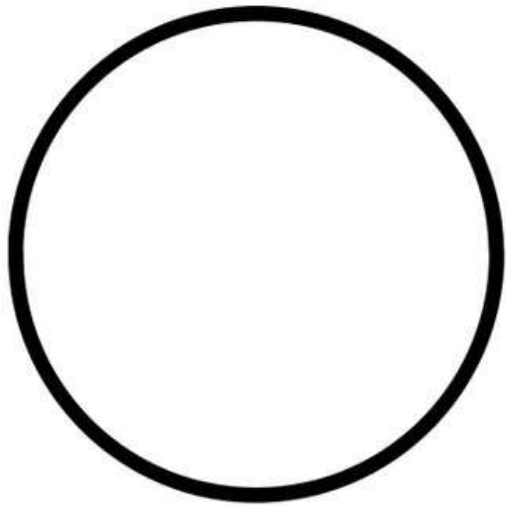
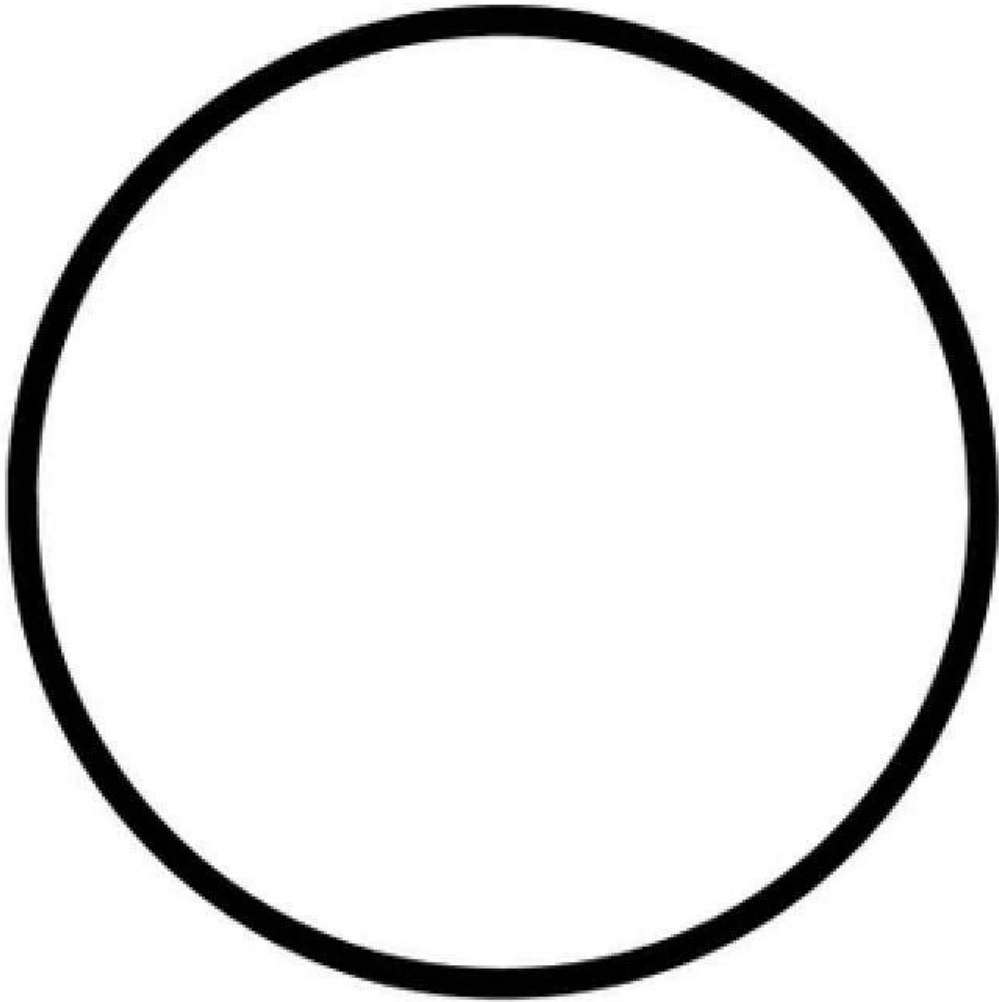

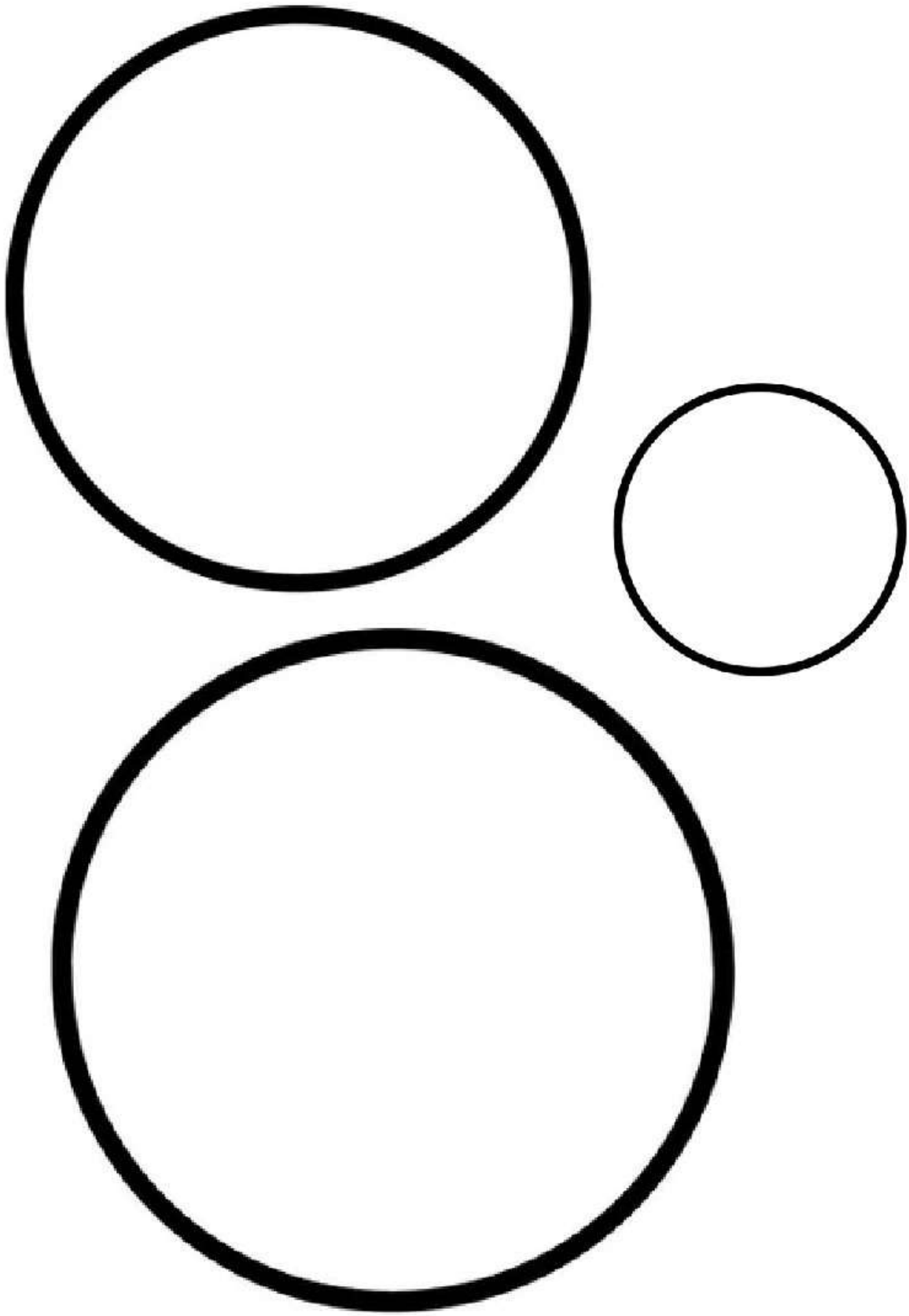

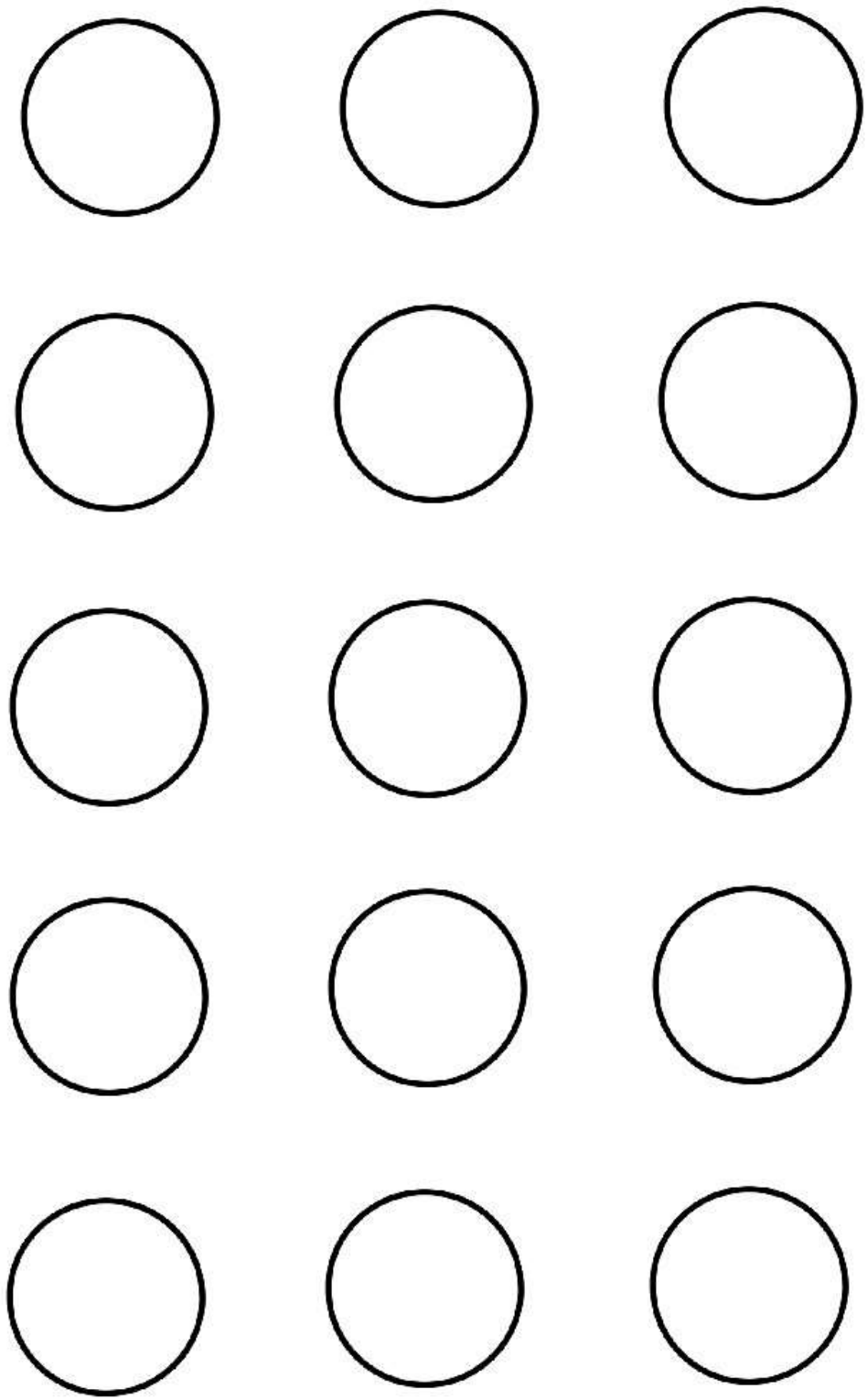

Day 3: Cross Craft

Supplies: Scratch off Crosses, Embroidery Floss, Tape

You will need either a single cross of a triple cross scratch off and three 12" strands of embroidery floss in variable colors. These scratch off crosses normally include a scratch tool, but cuticle sticks or small short appetizer size skewer sticks work as well. Distribute a cross and scratch tool to each child and allow them to decorate their cross by scratching off to reveal colors beneath. Halfway through the time allotted, distribute three 12" embroidery floss strands in three different colors to each child. Help them to knot and tape one end as shown before braiding. Use simple braid technique by crossing the right strand over the middle, then the left strand over what is now the middle strand, etc. Once complete, these braids will go through the pre-punched hole on the cross.

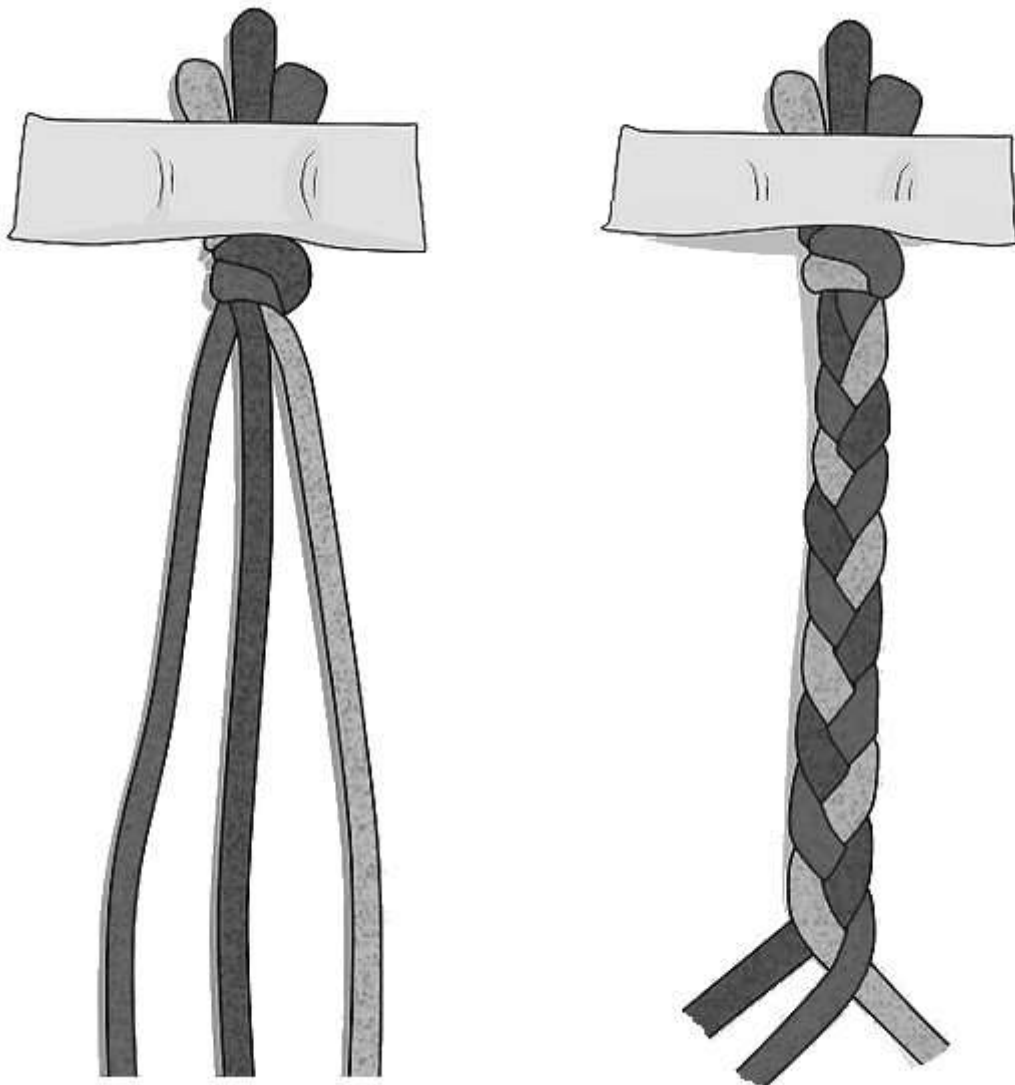

For preschool kids, yarn may be substituted for embroidery floss as it is easier to manipulate.

Day 4: Friendship Bracelet Gospel Craft

Supplies: 10" cord and 5 pony beads (one each in yellow, black, red, white and green) per child

Instructions:

1. Cut a length of cording at 10-12 inches long. This can be cut down later, if needed.
2. Thread the pony beads on the leather in the following order: yellow(gold), black, red, white, and green.
3. Slide the beads to the center of the cord and add a knot beside the green bead. Add another knot at the end of the yellow bead so that the five beads stay together..
4. Fold the ends of the bracelet over and tie one end to the bracelet loop. Then tie the other end to the bracelet loop so that the bracelet is adjustable.
5. Tell the kids the meaning of each color as they make their bracelets. If they finish early, have them practice telling the gospel story to each other using their bracelet beads.

Color Conversation:

Gold - Stands for God and Heaven because God is perfect and wants us to live with Him there.

Black - Stands for our sin. Adam and Eve sinned against God and we sin against Him by doing, saying and thinking things that don't please God.

Red - Stands for the blood of Jesus. Jesus shed His blood on the cross as payment for our Sin so that we can have a relationship with God.

White - Stands for Jesus giving us his perfect righteousness when we put our trust in Him so we can be clean before God. Green - Stands for growing in God. Once we accept Jesus as our Savior, we are friends of God and we can pray and read out Bible to get to know Him more.

Green - Stands for growing. Talking to God in prayer and hearing from God by reading the Bible are ways to continue to know Him and grow in God.



Color Conversation (Spanish):

Oro: Representa a Dios y al Cielo porque Dios es perfecto y quiere que vivamos con Él allí.

Negro: Representa nuestro pecado. Adán y Eva pecaron contra Dios y nosotros pecamos contra Él cuando hacemos, decimos o pensamos cosas que no agradan a Dios.

Rojo: Representa la sangre de Jesús. Jesús derramó Su sangre en la cruz como pago por nuestro pecado para que podamos tener una relación con Dios.

Blanco: Representa a Jesús dándonos su justicia perfecta cuando ponemos nuestra confianza en Él para que podamos estar limpios ante Dios.

Verde: Representa crecimiento. Hablar con Dios en oración y escuchar a Dios leyendo la Biblia son formas de continuar conociéndolo y creciendo en Dios.

Bible Adventure Games/Juegos

Hula Hoop Games

Game 1: Hula Hoop Flip Ball

This game is a slow paced relay game. Place one hula hoop for each team across a starting line. Instruct each player that they have to roll the tennis ball into the hula hoop. If it stops inside the hula hoop then flip the hula one time. If the ball does not stop inside the hula, then the player who tossed it picks it up and tosses it back to their teammate. This hula hoop flip game ends once a team reaches a preset finish line. You can adjust this game for younger kids by removing the stipulation that the ball has to land and stay in the hoop before they can flip it. For the younger kids, just say that the ball has to touch the hoop before it can be flipped. They can also work in pairs to flip the hoop if needed.

Supplies: 4-6 Hula Hoops, 4-6 tennis balls

Game 2: Capture the Treasure

Place four hula hoops on the ground in quadrants. Place 10 random soft toy items such as beanie babies, frisbee, foam balls, kick ball or rubber duckie in each Hula Hoop . Divide the group into four teams and assign them to a hula hoop. When the music begins (or whistle is blown) kids run and steal one item only at a time from someone else's circle and place it in their hula hoop. When the music stops (or the whistle is blown again) the team with the most items in their hula hoop wins.

Supplies: Four Hula Hoops, 40 random items, bluetooth speaker or whistle

Game 3: Hula Hoop Hopscotch

Place 25 Hula Hoops from one end of the playing field to the other in a snake design. (Or draw 25 circles on the pavement with sidewalk chalk) Divide kids into two teams and place them at each end of the field. Kids must hop from hoop to hoop until they meet each other at which time they must play rock, paper, scissors.

The loser must go back to his team while the winner continues to hop until he meets the next person on the opposing team. They play rock, paper, scissors again and this continues until someone makes it all the way through the hoops. When he completes this his team is awarded a point.

Supplies: 25 hoops (or sidewalk chalk)

Game 4: Musical Hoops

Main Idea: Place 4 to six hoops around the playing field and have the kids walk over them (stepping on the hoop means you are instantly out) until the music stops at which time they have to sit down inside the hoop. You can even have rounds where there can be two people in the hoop when the music stops and then times when there can only be one in the hoop when the music stops. Take out hoops until there is one or two winners. Just good ole fashioned musical chairs!

Supplies: 4 to 8 hoops.

Game 5: Tin Pan Hoop

Main Idea: Place 6 to 10 hoops around the playing field. Have the kids walk around the field randomly as you take a wooden spoon and hit a cookie sheet a certain number of times and then say : "go." If you hit the pan 6 times, they must get in groups of 6 people, find a hoop and join hands and squat down around it. The last group to get together and squat are out! Go until you have two or three winners left.

Supplies: 6 to 10 hoops.

Soccer Ball Games

Game 6: Soccer Stomp (balloons)

Have kids tie balloons on one ankle. Divide the group into two teams. Start with the ball in the middle and have the kids pass the ball to another kid who still has an inflated balloon. Other players will try to stomp opponents' balloons. The winning goal must be won by a player with their balloon still intact.

Supplies: soccer ball, 4 cones for goals, up to 100 inflated balloons depending on the number of kids, 2-3 rolls of curling ribbon to tie balloons

Game 7: Crab Soccer

Divide the kids into two teams. Play is traditional soccer play except kids are on their hands and feet in a crab walk position.

Supplies: soccer ball, 4 cones for goals

Game 8: Soccer Switch

Main Idea: place two cones at the end of each end of the playing field marking the soccer goals.

Divide the kids into two teams and line them up along the sides of the field. The front of the line will be the closest to their goal. Send in the first 3-4 kids on each team; after 5-10 minutes of play, say "switch" and the next 3-4 kids go in while the last group goes out. Kids on each team compete until one team scores. Kids on the sidelines encourage their team and assist in keeping the ball in play but they cannot enter the playing field.

Supplies: four cones, soccer ball

Puppet Skit Guide

Supplies Needed: Sheets and heavy clips for draping, PVC (cut to fit trunks for frame assembly), plumbers tape

Puppet Stage Instructions: Sample plan for portable puppet stage below. Recommend cutting longer lengths of PVC shorter for transport as needed. Add additional connectors if additional cuts are made. Avoid glue for easy disassembly. Use plumbers tape instead if connections (indicated with arrows) are too loose. Cover with dark cloth.

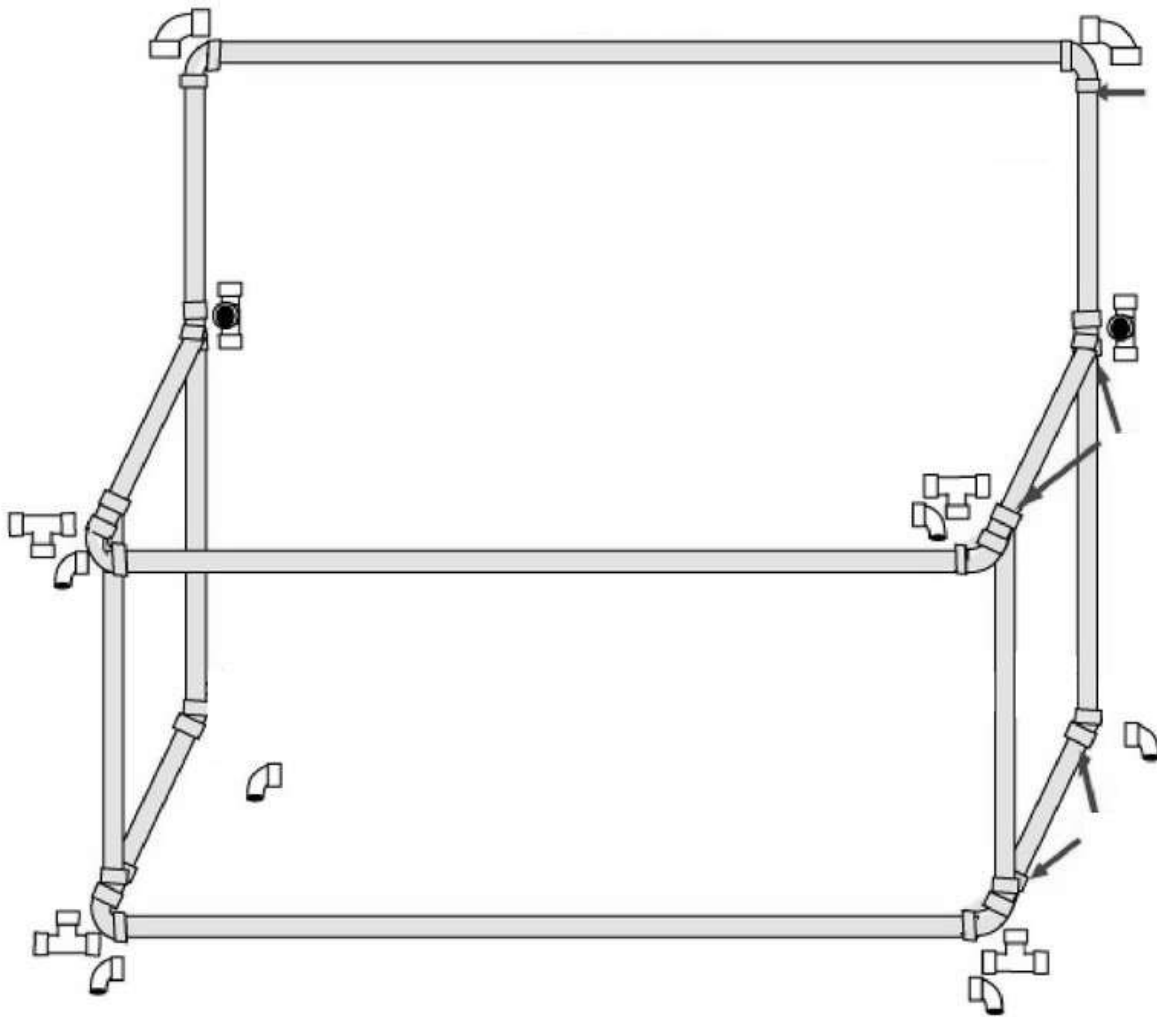

Aventura Biblica Musica

| | Bible Point | Memory Verse | Today's Song | Lesson |
|-------|----------------------|--------------|-------------------|--|
| Day 1 | Jesus is our Creator | John 1:1 | Eres Mi Padre | Creation and The Fall |
| Day 2 | Jesus is our Hope | Romans 3:23 | Te Alabare | Parable of the Workers in Vineyard |
| Day 3 | Jesus is our Savior | Romans 5:8 | Jesus Mi Salvador | Crucifixion and The Thief on the Cross |
| Day 4 | Jesus is our Friend | Romans 15:13 | Dios es Mi Amigo | Resurrection and New Life |

It is important to teach at least one new song each day and emphasize that song during the worship rotations. Other songs can be integrated at your discretion. In addition to the lyrics and links for these four main songs, additional song suggestions are below.

Eres Mi Padre - Xtreme Kids

<https://www.youtube.com/watch?v=3Uyh50an-Nk>

Despierto en la mañana
No sé qué aventura me espera
Cuando salga por la puerta hoy
La vida es un regalo de Dios

Tomado de tu mano nada me da temor
Venga lo que venga listo estoy
Tú eres mi canción

(Pre-coro)
Amor tan perfecto
Poder tan inmenso
Tus ojos siempre atentos en mí

(Coro)
Tú, Dios, eres mi padre
Único, inigualable
Siempre, siempre tú conmigo estás

Siento tu amor en mí
Tu luz me guiará hasta el fin
De todo mal me librarás

Verso

En mi casa, en el parque, en la escuela o en la calle
No existe un lugar donde no me acompañes
Quiero que todos conozcan de tu amor

Cuando llega la noche y todos se van a la cama
Quiero en mis sueños escuchar que tú me amas
Y cada día darte adoración

(Pre-coro)

Amor tan perfecto
Poder tan inmenso
Tus ojos siempre atentos en mí

(Coro)

Tú, Dios, eres mi padre
Único, inigualable
Siempre, siempre tú conmigo estás

Siento tu amor en mí
Tu luz me guiará hasta el fin
De todo mal me librarás

Amor tan perfecto
Poder tan inmenso
Tus ojos siempre atentos en mí

(Coro)

Tú, Dios, eres mi padre
Único, inigualable
Siempre, siempre tú conmigo estás

Siento tu amor en mí
Tu luz me guiará hasta el fin
De todo mal me librarás

Te Alabare - Andy y Amy

<https://www.youtube.com/watch?v=c-djfiLgTEg>

Me diste pies para bailar

Me diste manos para alzar

oidos para escuchar

y ojos para poder mirarte

Me diste boca para cantar

Me diste mucho amor para dar

y pusiste en mi corazón

que late fuerte al escucharte

Hey, hey

Hey, hey, hey, hey

Y bailaré, te alabare

te escuchare, te miraré

te cantaré y gritaré

al mundo que

¡Te amo!

Y bailaré, te alabare

te escuchare, te miraré

te cantaré y gritaré

al mundo que

¡Te amo!

Me diste pies para bailar

Me diste manos para alzar

oídos para escuchar

y ojos para poder mirarte

Me diste boca para cantar
Me diste mucho amor para dar
y pusiste en mi corazón
que late fuerte al escucharte

¡Hey, hey
Hey, hey, hey, hey!

Y bailaré te alabare
te escuchare, te miraré
te cantaré y gritaré
al mundo que

¡Te amo!

Y bailaré te alabare
te escuchare, te miraré
te cantaré y gritaré
al mundo que

¡Te amo!

¡Te amo!

Voy a cuidar donde ando
Voy a cuidar lo que toco
Voy a cuidar lo que escucho
Voy a cuidar lo que veo
Voy a cuidar lo que hablo
Voy a cuidar mi corazón

Para ti

Para ti

Jesus Mi Salvador - Generation 12 Kids

<https://www.youtube.com/watch?v=dOreoljbCjU>

Tengo un amigo fiel que siempre me cuida

Y a mi corazón, da mucha alegría

Él creó los peces y el mar, cada estrella puso en su lugar

Me dio un gran regalo y fue su amor y ahora quiero cantar

Mis manos alzaré, moviendo la cabeza, dando muchas vueltas

Muy, muy alto saltaré

Y con todas mis fuerzas, danzaré a Jesús, mi salvador

Tengo un amigo fiel que siempre me cuida

Y a mi corazón, da mucha alegría

Él creó la luna y el sol, le dio al arcoíris todo su color

Me dio un gran regalo y fue su amor

Y ahora quiero gritarlo con mi corazón cantarlo

Mis manos alzaré, moviendo la cabeza, dando muchas vueltas

Muy, muy alto saltaré

Y con todas mis fuerzas danzaré a Jesús, mi salvador

Mis manos alzaré, moviendo la cabeza, dando muchas vueltas

Muy, muy alto saltaré

Y con todas mis fuerzas danzaré a Jesús, mi salvador

Oh oh, oh, oh, oh, oh, oh

Oh, oh, danzaré a Jesús, mi salvador

Oh oh, oh, oh, oh, oh, oh

Oh, oh danzaré a Jesús, mi salvador

Jesús, mi amigo fiel, con él yo cantaré

A él, yo alabaré y me divertiré

Jesús, mi amigo fiel, con él yo cantaré

A él, yo alabaré

Mis manos alzaré, moviendo la cabeza, dando muchas vueltas

Muy, muy alto saltaré

Y con todas mis fuerzas, danzaré a Jesús, mi salvador

Mis manos alzaré, moviendo la cabeza, dando muchas vueltas

Muy, muy alto saltaré

Y con todas mis fuerzas, danzaré a Jesús, mi salvador

Oh oh, uoh, oh, uoh, oh, oh

Oh, oh danzaré a Jesús, mi salvador

Oh oh, uoh, oh, uoh, oh, oh

Oh, oh danzaré a Jesús, mi salvador

Dios Es Mi Amigo - Yancy Ministries

<https://www.youtube.com/watch?v=OE-BdHSjv9c>

Dios es mi amigo
Mi amigo, mi amigo
Dios es mi amigo
A mi lado está

Domingo, lunes, martes, miércoles, jueves, viernes, y sábado

Dios es mi amigo
A mi lado está

Interludio/Interlude (guitar)

¡Canta conmigo!

Dios es mi amigo
Mi amigo, mi amigo
Dios es mi amigo
A mi lado está

Domingo, lunes, martes, miércoles, jueves, viernes, y sábado

A mi lado está
A mi lado está

Mi Dios Es Tan Grande

https://www.youtube.com/watch?v=TP_hJldkQ-k

Mi Dios es tan grande,
tan fuerte y poderoso,
no hay nada
que él no pueda hacer.

Mi Dios es tan grande,
tan fuerte y poderoso,
no hay nada
que él no pueda hacer.
Montañas créo,
los mares también
Pues todo lo hizo el Señor

Mi Dios es tan grande,
tan fuerte y poderoso,
no hay nada
que él no pueda hacer.

Mi Dios es tan grande,
tan fuerte y poderoso,
no hay nada
que él no pueda hacer.

Mi Dios es tan grande,
tan fuerte y poderoso,
no hay nada
que él no pueda hacer.

Montañas créo,
los mares también
Pues todo lo hizo el Señor

Mi Dios es tan grande,
tan fuerte y poderoso,
no hay nada
que él no pueda hacer.

No hay nada
que él no pueda hacer.
No hay nada
que él no pueda hacer.

Ir - Yancy Ministries

<https://www.youtube.com/watch?v=KJTtgXDWwE8>

Vivimos en un gran mundo
Que necesita un gran amor

Tenemos que decirles
A cada niño y niña

Tenemos que ir, ir, ir
Jesus dijo ir, ir, ir

Tenemos que decirles
de Jesus y su amor

Ir, ir, ir
Ir por el mundo

Ir , ir, ir
Enseñarles de su amor

Ir, ir, ir
Ir por el mundo

Ir , ir, ir
Enseñarles de su amor

Vivimos en un gran mundo
Que necesita un gran amor

Tenemos que decirles
A cada niño y niña

Tenemos que ir, ir, ir
Jesus dijo ir, ir, ir

Tenemos que decirles
de Jesus y su amor

Ir, ir, ir
Ir por el mundo

Ir , ir, ir
Enseñarles de su amor

Ir, ir, ir
Ir por el mundo

Ir , ir, ir
Enseñarles de su amor
¡Sí!

Vivimos en un gran mundo
Que necesita un gran amor

Tenemos que decirles
A cada niño y niña

Ir, ir, ir
Ir por el mundo

Ir , ir, ir
Enseñarles de su amor

Tenemos que
Ir, ir, ir
Ir por el mundo

Ir , ir, ir
Enseñarles de su amor

Jesus los ama y Te ama a ti

¡Sí!

Guitar Music

Es Un Gran Dia

Es Un Gran Dia para alabar a Dios
Es Un Gran Dia para alabar a Dios
Es Un Gran Dia para alabar a Dios
Andando En La Luz Del Señor

Anda, Anda, Anda, Anda, En La Luz
Anda, Anda, Anda, Anda, En La Luz
Anda, Anda, Anda, Anda, En La Luz
Andando en La Luz Del Señor

Making Melody in my Heart (Teach in English)

Making melody in my heart * 3
unto the king of kings.

Now Thumbs up
Making melody in my heart * 3
unto the king of kings.

So Thumbs up, elbows out
Making melody in my heart * 3
unto the king of kings.

Thumbs up, elbows out, knees bend
Making melody in my heart * 3
unto the king of kings.

So Thumbs up, elbows out, knees bend, feet apart
Making melody in my heart * 3
unto the king of kings.

Thumbs up, elbows out, knees bend, feet apart, turn around
Making melody in my heart * 3
unto the king of kings.

So Thumbs up, elbows out, knees bend, feet apart, turn around, on your leg
Making melody in my heart * 3
unto the king of kings.

Closing Lessons

Closing: Day 1

Jesus loved us so much that he created us in his own image to reflect his love. Jesus is our creator! In today's Bible adventure we learned that it didn't take long for Adam and Eve to disobey God. God told them not to eat of the tree of knowledge of good and evil, but Eve listened to Satan and was tempted to be like God. God created a perfect world where He walked and talked with them in the Garden, but when Eve disobeyed and Adam followed her, sin entered the world and the friendship with God was broken. Ever since then, we were all enemies of God.

So if you have been wondering why people get mad at each other, argue and fight and why life is so messed up, now you know!

But we can't blame everything on Adam and Eve; whenever we get a chance, we all disobey God and sin. Romans 3:23 says all have sinned and fall short of the glory of God. We are going to take a closer look at what our sin is tomorrow, but for today let's remember what the first sin looked like.

Adam and Eve wanted to be like God. Do you think we have the same thought? When we disobey God, it is telling God we know better than He does. We are trying to be our own God! Or when we try to do good works because we think surely God won't punish us if we are good, we are still saying we know more than God.

Those sins separate us from God and because of sin, Adam and Eve were shut out of the garden and we (you and me) cannot get into Heaven--- that is without Jesus!

Remember I told you that snake Satan would be crushed in the end. Genesis tells us that the offspring of Eve, meaning one of her children's children's children, would win the battle over Satan. The devil wanted our friendship with God to be broken, but God made a way for us to be friends with God again. He sent Jesus, who is also God. It may be hard to understand, but God is three persons in one: God the Father, God the Son and God the Holy Spirit. Jesus came down from Heaven to be born of a virgin. He lived a perfect life without sin, never disobeying God; and to restore our friendship with God, he paid for our sins with his life and death on the cross.

Tonight before you go to bed, I want you to think about how you sin and disobey God. And think about how you would like to be a friend and not an enemy of God and tomorrow we will learn more. Don't forget to invite a friend to hear about Jesus!

Closing: Day 2

Earlier we learned that Romans 6:23 says, "For the wages of sin is death, but the gift of God is eternal life in Jesus Christ our Lord."

So do you know what sin is? Everyone, show me your hands. Ok, follow my lead. Sin is anything you say (point to your mouth), anything you do (show your hands), or anything you think (point to your brain) that doesn't please God.

Eve sinned when she disobeyed God and Adam sinned when he also disobeyed. I know that I have sinned against God many times. Can you think of how you sin against God? Did you disobey your parents, push your brother, think ugly thoughts about a kid at school? We all sin because we put things, and especially ourselves before God just like Eve did.

The verse in Romans tells us that we earn death and separation from God for our sins. But what does it tell us about how we get life with God in Heaven? That's right! It is a gift.

Jesus is our Hope! This is not like, "I hope I get a shiny new bike". Hope in Jesus is to believe He is who He says He is that He will do what He says He will do.

John 3:16 says it best, For God so loved the world that he gave his one and only Son that whoever believes in him shall not perish, but have everlasting life. Who is our hope for everlasting life with God in paradise? Jesus is our hope!

Do you know what perish means? It means to be lost. Have you ever been lost from your parents in a crowd? That is a scary feeling isn't it? We are lost when we don't accept the free gift that God has for us.

I am so glad that God is not just fair. He is better than fair! Being fair would mean I sinned and I deserve the punishment of death. But even from the beginning of creation, God had a plan for us to escape the punishment of our sin. I am so glad that I don't have to earn God's love. He gives it to us as a gift and all we have to do is receive it.

God is so gracious, that he made a bridge for us to have life! (Use the Bridge of Life skit.) Let's watch the Bridge to Life skit now!

Two Kingdoms & The Bridge to Life

4 Participants Needed: Narrator, Man, God, Satan

1. In the Beginning there was only God and His Kingdom of Light
2. He created Angels to Serve Him
3. Lucifer Rebelled Against God and was Cast Out to the Kingdom of Darkness
4. God wanted a creation to have relationship with so he made the earth and man
5. Man was one with God and walked and talked with God in friendship
6. Satan came to tempt man in the Garden God had created for him.
7. Man sinned and was cast out of the kingdom of Light into the Kingdom of Darkness to serve Satan
8. The earth and mankind were cursed by sin-
9. Every man born since has been born in sin
10. God loved his creation and wanted to be reunited with him in the Kingdom of Light
11. Man also longed to be with his creator for he had a void deep in his heart
12. Man tried to make his own way to God through
 - a. The Bridge of Good Works
 - b. The Bridge of Religion
13. God built the only bridge from the kingdom of Darkness back to the kingdom of Light- That Bridge was His only Son Jesus
14. Jesus came to earth, lived a sinless life, died on the cross, was buried and rose again the third day proving he has the power to forgive sins.
15. When we turn away from our sins and put our trust in Jesus only for eternal life we cross over from the kingdom of death and darkness to the kingdom of life and light. (John 5:24)

Closing: Day 3

Remember our first day's adventure with Adam and Eve? God warned them that if they disobeyed, they would surely die. But remember God had a plan from the beginning! The fact that they disobeyed wasn't a surprise to God. He didn't sit around talking to Jesus saying, "Oh, no! We created these beings and look at what they did! What are we going to do now?"

No! That is where the good news begins...

So how does God's plan work?

John 3:16 says that for God so loved the world that He gave His one and only Son, that whoever believes in Him would not perish, but have everlasting life. Jesus came to earth, not to punish us, but to save us by taking our punishment in our place!

You and I deserve death, but Jesus died for you and me.

Could your mother or father or anyone else take your punishment instead? Not a chance! The reason that Jesus' death was payment in full for your sin and my sin is that Jesus is perfect and never sinned. He is the Son of God and I know this is hard to understand but Jesus is God. In the beginning God created the heavens and the earth and who was there creating us with Him? Jesus is our creator! Remember that God is three in one: God the Father, God the Son and God the Holy Spirit. So Jesus as God's perfect Son paid the price for our sin on the cross in our place. This was God's plan from the beginning. Jesus is our Savior!

It amazes me so much that God knew we would not be obedient, but he created us anyway.

It amazes me that Jesus knew He would have to shed his own blood to pay for our sin; but he created us anyway and willingly left Heaven to be born as a baby and live knowing he would have to die on the cross with our sin and guilt on Him. Jesus lived and never sinned. Jesus is our hope!

Jesus allowed himself to be mocked, beaten and crucified. He gave up His life to pay the price we owed for our sin so that by accepting the gift of His payment, we can stand before God when it is our time to leave this earth. Every person will one day stand in front of God in judgment of their sin. If you have trusted in Jesus, you don't have to worry because instead of seeing our sin, God will see only Jesus' perfection.

(Use two identical white cloths, one clean and the other covered in filth and grease.)

This is what our sin looks like to God. Even when we try to do good things, they end up dirty---maybe because we want someone to notice how good we are instead of giving glory to God.

When we trust Jesus to pay for our sins and be our Lord and Savior, He takes our filthy rags and replaces them with Jesus' perfection. That's why when God looks at his children who have trusted Jesus, He sees us clean as Jesus and not filthy as our sin.

But that is not the end of the adventure! I have another clue for you to find in Romans. See if you can find the clue where the story continues?

Romans 10:9-10 says "If you declare with your mouth, "Jesus is Lord," and believe in your heart that God raised him from the dead, you will be saved. For it is with your heart that you believe and are justified, and it is with your mouth that you profess your faith and are saved."

That's right, Jesus died on the cross, but He did not stay dead! On the third day after his death, God raised Him from the dead. And when we trust Jesus as our Savior, we will rise up to meet him In Heaven after we leave this earth!

Right now, I want you to bow your head. Everyone should have their eyes closed. No looking around. I am going to ask you some questions.

Raise your hand if you believe that Jesus is the Son of God?
You can put your hands down.

Raise your hand if you understand that you have sinned against God?
You can put your hands down.

Raise your hand if you believe your sin has broken your friendship with God?
You can put your hands down.

Do you believe that Jesus died on the cross to take your punishment in your place?
You can put your hands down.

Do you believe that God raised Jesus from the dead?
You can put your hands down.

Now think about this next question seriously before you answer.
Do you want to put your life in Jesus' perfect hands by trusting Him to be your savior today?
Everyone except leaders keep their eyes closed. If you want to trust Jesus to be your Savior today, find a leader after we dismiss and ask them how. They would love to help you!

Parent Program: Day 4

Welcome

Welcome parents, thanking them for entrusting us with their children this week. Give an overview of each day's Bible Point, giving the children a chance to respond with "Arriba!"

| | |
|-------|----------------------|
| Day 1 | Jesus is our Creator |
| Day 2 | Jesus is our Hope |
| Day 3 | Jesus is our Savior |
| Day 4 | Jesus is our Friend |

Prayer

Music Presentation

Have the Music Leader lead the children in a large group or individual groups in a total of at least four songs.

Memory Verse Presentation (optional)

If a group or even an individual child is willing and able to recite one or more of the memory verses, it is good to do this immediately following their music presentation.

Gospel Presentation

Have the local pastor give a short 5 minute Gospel presentation to everyone with an opportunity to respond.

Prayer

Fellowship & Refreshment (if available)